

FRAUNHOFER INSTITUTE FOR SOLAR ENERGYSYSTEMS ISE
FRAUNHOFER INSTITUTE FOR INTEGRATED SYSTEMS AND DEVICE TECHNOLOGY IISB
ADVANCED SYSTEM TECHNOLOGY BRANCH OF FRAUNHOFER IOSB
FRAUNHOFER INSTITUTE FOR SYSTEMS AND INNOVATION RESEARCH ISI
FRAUNHOFER INSTITUTE FOR MECHANICS OF MATERIALS IWM

FRAUNHOFER TOPICS OF THE FUTURE »SUPERGRID«

Supergrid – Approach for the integration of renewable energy in Europe and North Africa

SUPERGRID STUDY

Approach for the integration of renewable energy in Europe and North Africa

Werner Platzer

Fraunhofer Institute for Solar Energy Systems ISE
Freiburg, 12th March 2016

Project number: 601160

Project partners: Fraunhofer ISI, Fraunhofer IISB, Fraunhofer IOSB/AST, Fraunhofer IWM

Co-authors:

Inga Boie, Mario Ragwitz, Christoph Kost, Jürgen Thoma
Alex Vogel, Thomas Fluri, Wulf Pfeiffer, Frank Burmeister,
Nils Tham, Martin Pudlik, Sven Bohn, Michael Agsten,
Peter Bretschneider, Dirk Westermann, Dirk Kranzer, Thomas Schlegl

Inhalt

1	Summary	4
2	Introduction	5
3	Chances for the integration of renewable energies in the international transmission grid	6
3.1	Methodologies and assumptions.....	6
3.1.1	Models.....	6
3.1.2	Scenarios and assumptions.....	7
3.2	Results	8
3.2.1	Long-term scenarios for electricity demand, production structures and transnational export opportunities	8
3.2.1.1	Future electricity demands in North Africa.....	8
3.2.1.2	Wind and solar potential in North Africa	8
3.2.1.3	Electricity production structure and costs for 2030 and 2050	9
3.2.1.4	Consequences for the transnational electricity export.....	10
3.2.2	Regional planning of the production of renewable energy considering transmission capacities	11
3.2.2.1	Site selection and power plant planning.....	11
3.2.2.2	Regional power exchange: impact of current exports	12
3.2.3	Expansion of grid capacities and challenges	12
3.2.3.1	AC transmission grid	12
3.2.3.2	Development of a HVDC overlay grid	14
3.3	Conclusions	16
4	Technological developments for the integration of renewable energies in the international transmission grid	18
4.1	Operational management and stability of new grid structures.....	18
4.1.1	Grid operation and grid stability.....	18
4.1.2	Grid protection and grid security.....	19
4.2	Development of components for medium voltage systems.....	21
4.2.1	New PV power plant structures	21
4.2.2	Medium voltage power electronics.....	22
4.2.3	Glas film capacitor	22
4.3	Thermal energy storage for CSP power plants.....	25
4.3.1	State of technology.....	25
4.3.2	Optimization of CSP plants with high temperature storage	26
4.3.2.1	Results	27
4.3.3	Reliability, safety and durability of thermal storage.....	28
4.4	Conclusions	30
5	Regulatory issues and political obstacles - policies	32
5.1	Analysis of the regulatory framework in North Africa	32
5.2	Recommendations for future RES promotion schemes	32
5.3	Conclusions	35
6	List of Figures	36
7	References	37

1

Summary

In the long term, the increasing electricity demand in Northern Africa can be covered completely by renewable energy (RE). On top of that, considerable potentials exist to export electricity to Europe.

Concentrated solar thermal power plants (CSP) using thermal energy storage gain considerable importance, when high electricity demand is combined with ambitious climate change protection. Then large fluctuating capacities from wind energy and photovoltaics have to be complemented by dispatchable and firm capacity from CSP. An optimization based on regional potentials and overall cost shows the parallel use of all three renewables.

Photovoltaics (PV) should be mainly used locally close to the demand. The advantage of higher irradiation levels in arid areas far from the coasts is overcompensated by high transmission costs. By contrast, CSP needs the high direct radiation levels of these areas but is able to utilize and finance the required transmission lines, because CSP has more full-load hours and provides electricity on demand. Wind energy in Northern Africa has high and cost-efficient potentials, but the site selection is dependent on local wind conditions.

A high percentage of RE electricity may have considerable economic advantages for the region in the long run. Similarly the integration of European and Northern African grids leads to lower total cost. A high percentage of fluctuating generation favours a stronger integration of national electricity markets. However the grid extensions depend considerably on the chosen sites for renewables. Thus a complete overview of all planned measures is needed for an optimal solution for the energy sector.

A transmission grid based on alternating current (AC) technology would require enormous grid capacities and high investments. High voltage direct current lines (HVDC) are therefore recommended both for trans-national interconnectors as well as for a meshed overlay grid on top of the existing AC structures in both regions. Operation and fault detection methods have been suggested for such a technology in the study.

Technology developments in the area of medium voltage technology will allow direct coupling of distributed generators with lower losses. New components have been developed in a first step. Thermal energy storage with molten salts has a good potential to further lower the cost of dispatchable solar electricity using CSP. Simulation tools have been extended to support performance assessment and development of operation strategies for CSP plants using different storage types.

An assessment of the existing framework and possible RE support systems in Northern Africa shows that increased implementation of RE requires the creation of reliable regulations and liberalization of the markets.

Support measures for RE should be adapted in different phases of the implementation. Key elements of the policies should be the need for security for investors, increasing competitiveness in the market and the medium-term to long-term development of options to export electricity to Europe.

2 Introduction

In order to integrate renewable generation worldwide in a future electricity system to a politically desirable extent, grid and storage technologies have to be adapted to meet this target. In the Fraunhofer SUPERGRID project, key technologies have been developed and optimized in a holistic system approach at the interface between generation and electricity grid.

Using high or medium voltage direct current transmission (H/MVDC), distributed electricity generators may be coupled over wide distances. Advantages are small losses and a possible use of underground cables. Disadvantages of conventional AC transmission can be avoided. A development of new components and control strategies is needed in order to improve efficiency, flexibility and cost in comparison to technologies available today. New methods of grid operation are required to use the switching potential of components as for example high performance power converters to optimize power fluxes. Other challenges relate to the safe and stable operation of DC grids, controlling their power fluxes and consequences for the grid code. Parallel stable operation of coupled AC and DC grids has to be ensured.

It is of similar importance to efficiently integrate various storage systems into the grids, e.g. pump storage, batteries or compressed air storage. Fluctuations of generation can be buffered in the grid using these technologies. However, currently the economically viable capacities are limited and extensions of electrical storage are costly. Thermal energy storage for solar thermal power plants on the other hand provides dispatchable and firm capacity at comparatively low cost. However the development of different high-temperature storage technologies and optimized concepts combining various components is in an early phase. For the relevant temperature range of 250°C-550°C, liquid molten salts, phase change materials utilizing the latent heat of the liquid-solid transition of salts (nitrates, nitrites) and solid sensible-heat storage concepts using high temperature concrete are investigated. More detailed information on the costs, corrosion mechanisms and thermomechanical performance of heat exchangers, containers and pumps is needed. Also, material parameters and dimensioning have to be adapted.

The optimization of generation, transmission and storage capacities with actual demand needs a political and regulatory framework. On the economic and political level, the questions pertain to the deployment and operation strategies as well as to the framework for electricity markets within Europe and Northern Africa. Our analysis starts with the current situation and develops scenarios for future developments of electricity demand, generation, storage and transmission requirements when using renewables.

A substantial and fast supranational extension of renewable generation on the basis of wind, photovoltaics and solar thermal power plants needs a fundamental modification of our electricity grid and better integration of renewable generation, electricity demand and storage technology. Therefore our research within the SUPERGRID project focused on optimization of the energy sector as well as on selected technological problems in DC grids and thermal energy storage.

3 Chances for the integration of renewable energy in the international transmission grid

3.1 Methodologies and assumptions

3.1.1 Models

In order to cover the various dimensions of the technical challenges, which are associated with the integration of renewable energy into regional and inter-regional electricity markets, three models were combined.

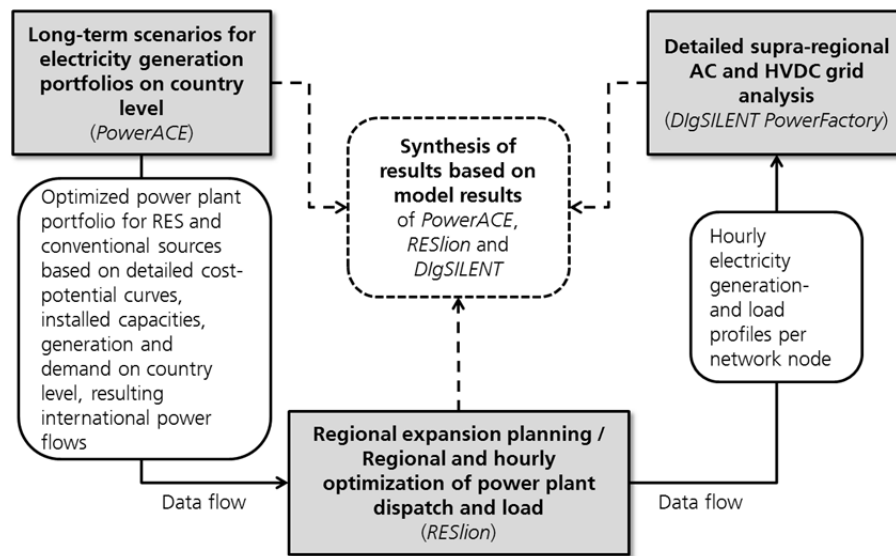

Figure 3-1: Illustration of the interfaces and data flows between the three models

The electricity system in Europe and the five countries of North Africa (Morocco, Algeria, Tunisia, Libya and Egypt) was represented in the PowerACE model. In addition, existing solar and wind potentials were analysed with a geographic information system (ArcGIS). The available land areas for renewable energy were identified, taking into account existing uses (e.g. agriculture, settlements, nature reserves, restricted zone etc.) and geographical data (topology, nature of the ground, elevation, etc.). Using the solar radiation and wind data, the regional generation potentials were determined. The future power needs of North African countries were estimated, taking into account the existing population and economic growth as well as trends in the field of energy efficiency. Thus the (cost) optimal composition of power plants [1] was determined considering an international electricity system.

In a second step, the regionally based site selection and hourly power plant operation were examined using the RESlion model. The model considers existing power plants, regional power demand and power generation as well as limitations of the grid capacity. In a total of 28 regions within North Africa, local sites for renewable power plants were chosen on the basis of hourly weather data. Further, the operation was optimized, mainly to meet regional needs.

In the third step, the existing structures of the transmission grid starting with the 220 kV level and higher were modelled. Their ability to integrate renewable electricity to the grid was examined, using the simulation tool DigSILENT PowerFactory. Different scenarios for expansion in AC and DC technology were analysed. An optimal operation

management system was designed. In addition, a superimposed high-voltage DC power grid (HVDC grid) was developed and modelled in detail. The data streams and interfaces between the three models are shown in Figure 3-1.

Chances for the integration of renewable energy in the international transmission grid

3.1.2 Scenarios and assumptions

For the expansion of renewable energy by 2050, four different scenarios were defined [2,3], which differ in the following features (Figure 3-2):

- Level of ambition in CO₂ reduction targets,
- Expansion of the grid infrastructure between North Africa and Europe (Electricity export to Europe, yes or no)
- Progress in energy efficiency measures and electricity demand in North Africa

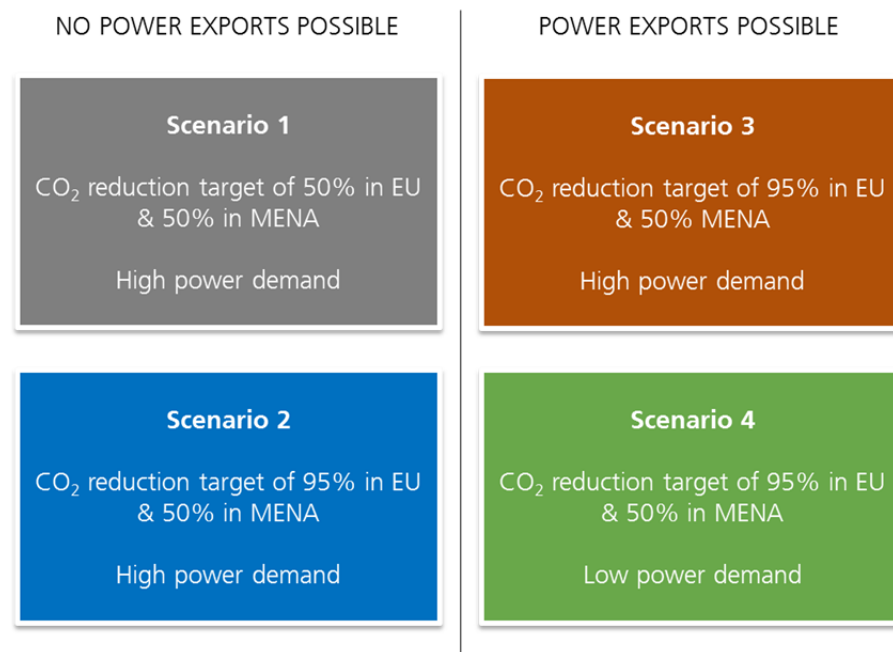

Figure 3-2: Framework scenarios for the future development

Assumptions on future technology costs and parameters as well as fuel costs are summarized in Table 3-1.

Table 3-1: Cost and technology assumptions in renewable and conventional technologies in the years 2030 and 2050

Technology	Spec. Investment costs [€/kW]		O&M costs [€/kW/a]		Fuel costs [€/MWh]		Service life [years]	Efficiency [%]
	2030	2050	2030	2050	2030	2050		
Wind	1000	900	30	30	0	0	25	-
PV	730	700	30	19	0	0	25	-
CSP	3300	2660	64	45	0	0	30	-
Gas-GT	380	380	9.7	9.7	27.68	26.82	30	40
Gas-CCGT	750	750	11.1	11.1	27.68	26.82	30	60
Lignite	1450	1450	34.5	34.5	7.47	6.86	40	48
Black coal	1500	1500	45	45	3.75	3.75	40	47
Pumped storage	1700	1700	28.9	28.9	0	0	40	91

3.2 Results

3.2.1 Long-term scenarios for electricity demand, production structures and trans-national export opportunities

3.2.1.1 Future electricity demands in North Africa

The development of the electricity demands in North Africa until 2050 was determined on the basis of an econometric top-down model using macroeconomic parameters such as the growth of the gross domestic product (GDP), the development of energy intensity, etc. For the European data, existing studies were used [4,5].

In the first scenario with a high demand, »status quo«, an increase by a factor of 4.3 in the electricity demand is expected compared to 2014.

In the second scenario, »Energy efficiency«, with a lower demand development - due to a 17% increase in energy efficiency by the year 2050 - this factor is reduced to approximately 3.3 (Figure 3-3).

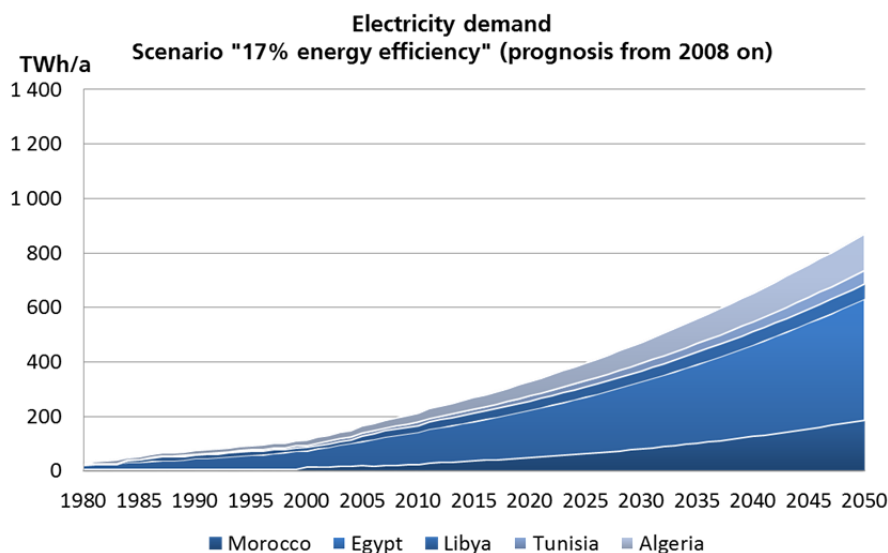

Figure 3-3: Trend of the electricity demand in North Africa in 2050 in the »Energy Efficiency« scenario

The total electricity demand for 2030 (2050) of North Africa is 552 (1070) TWh / a in the »Status Quo« scenario and 473 (871) TWh / a in the »Energy Efficiency« scenario.

3.2.1.2 Wind and solar potential in North Africa

Based on a GIS analysis with high spatial resolution, cost potential curves were calculated for the North African countries for the years 2030 and 2050, which are shown in Figure 3-4 cumulatively for all countries. The total technical potential of the considered technologies in North Africa exceeds the assumed electricity demand of North Africa and Europe of 5850 TWh in 2050 by a large factor. Therefore, only a section of the cost potentials is shown. It turns out that one may meet the electricity needs of North Africa by wind, CSP and PV alone. Additionally, it would be possible to export electricity to Europe. Wind power has the lowest generation costs at favourable locations, but also PV and CSP can be installed economically within this time frame. In 2050, the electricity production costs for the generation potential of 2,000 TWh / a for wind power are € 50 / MWh, for PV below 48 € / MWh and for CSP under € 56 / MWh.

The specific uses and the temporal availability of each technology were taken into account in our modelling.

Chances for the integration of renewable energy in the international transmission grid

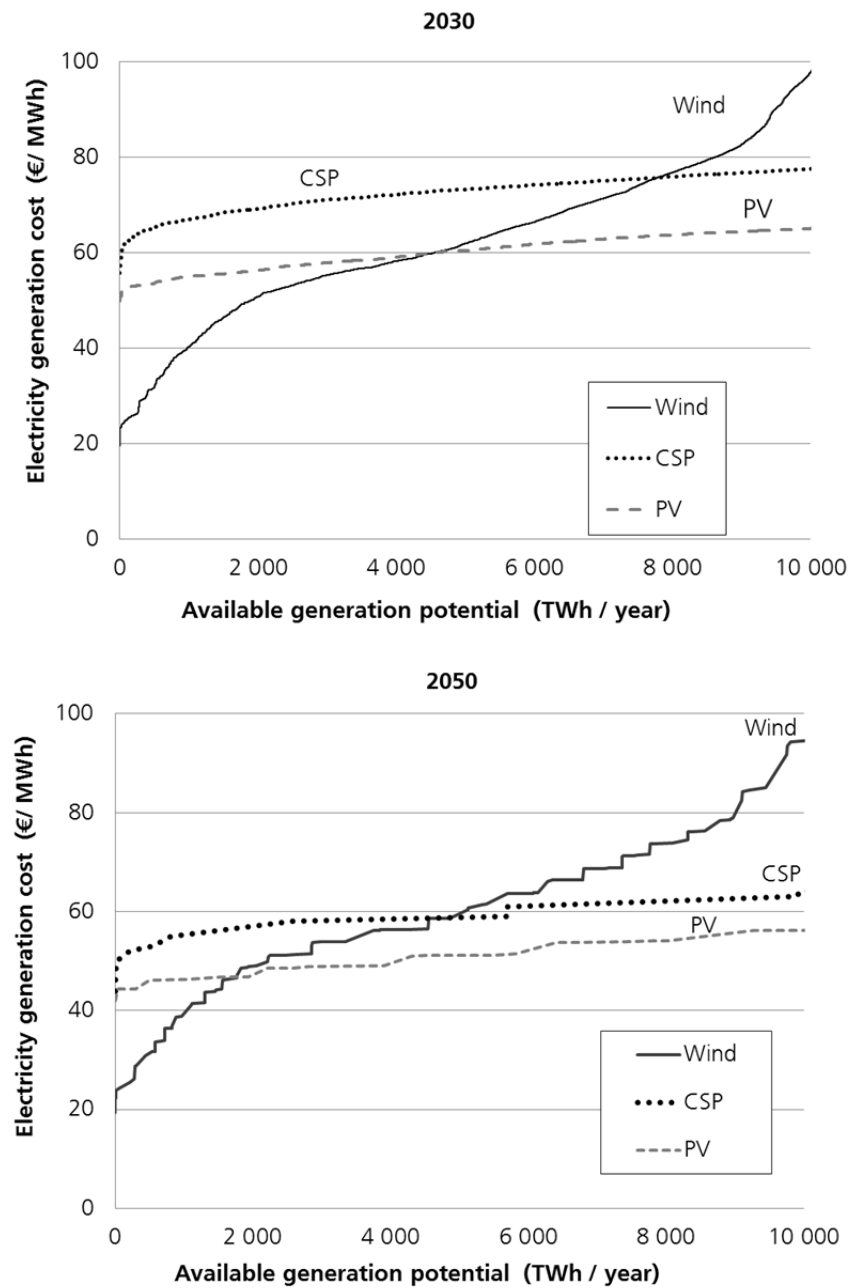

Figure 3-4: Cost potential curves for North Africa - 2030 and 2050

3.2.1.3 Electricity production structure and costs for 2030 and 2050

The political objectives and the framework conditions of the scenarios also play a key role in the optimization of the power plant technology mix for the years 2030 and 2050 (Table 3-2).

Table 3-2: Composition of the power plant mix in North Africa for 2030 and 2050

	Production per Technology for 2030/2050 [TWh/a]			
	Scenario 1	Scenario 2	Scenario 3	Scenario 4
Wind	246/618	292/737	315/965	252/735
PV	21/97	35/86	42/118	17/94
CSP	0/199	0/303	0/416	0/222
Gas-GT	4/8	5/3	3/3	3/4
Gas-CCGT	6/125	19/68	11/21	1/38
Gas (existing)	123/0	125/0	142/0	150/0
Coal	81/47	19/0	22/1	30/3
Hydro	50/50	50/50	50/50	50/50
Total	532/1143	545/1247	586/1575	503/1146
RES share	59/83%	68/93%	68/98%	63/96%

Chances for the integration of renewable energy in the international transmission grid

All scenarios reach very high shares of renewable energy between 59% and 68% in 2030 and up to 98% in 2050. The renewable electricity production is dominated by wind. CSP with thermal storage is needed, especially after 2030, to replace gas and coal with dispatchable and reliable generation and grid-balancing tasks. At the beginning of the transformation process, conventional power plants will be able to ensure the hourly balancing of the energy system. Grid amplifications at national level are not yet considered. The advantages of electricity market integration of EU and NA (Table 3-3) and the cost benefits of renewable energy are reflected, especially when considering energy efficiency gains (Scenario 4).

Table 3-3: Costs of the energy system in 2030 and 2050 for EU and NA

	Power generation costs 2030/2050 [€/MWh]				EU-NA Total system costs 2030/2050 [billion €] (incl. Interconnectors)
	NA	EU	Average EU-NA	EU-NA incl. Interconnectors	
Scenario 1	40/50	45/55	45/54	46/56	211/333
Scenario 2	42/55	52/64	51/62	52/68	240/401
Scenario 3	41/52	51/61	50/59	52/65	239/384
Scenario 4	40/48	48/58	47/55	49/60	178/245

3.2.1.4 Consequences for trans-national electricity export

Trans-national net electricity flows will grow significantly with increasing expansion of renewables. However, the expansion of the grid capacities may be significantly reduced by achieving a reduction of the electricity demand by energy efficiency measures (Table 3-4 and Figure 3-5).

Table 3-4 Trans-national net current flows for the four scenarios [TWh]

	North Africa		North Africa - Europe		Total	
	2030	2050	2030	2050	2030	2050
Scenario 1	4	28	-	-	4	28
Scenario 2	5	37	-	-	5	37
Scenario 3	6	117	42	347	48	465
Scenario 4	4	68	19	191	24	259

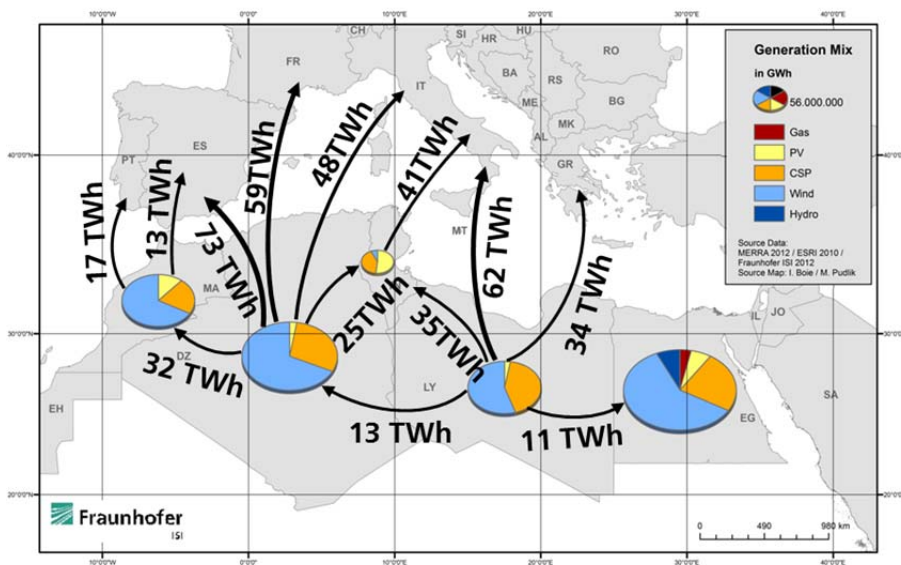

Figure 3-5: Visualization of the net electricity transmission in 2050 (Scenario 3)

3.2.2 Regional planning of the production of renewable energy considering transmission capacities

3.2.2.1 Site selection and power plant planning

Based on the expansion paths for renewable energy just described, the optimal power plant sites in the different regions were determined for each technology (Figure 3-6). The transmission capacities at subnational level were taken into consideration.

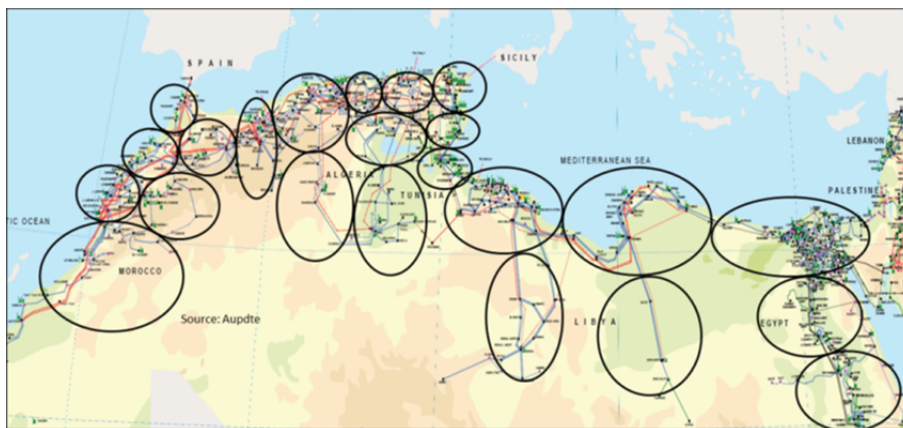

Figure 3-6: The 28 regions considered in NA (Source grid map: AUPDTE, 2011 [6])

For photovoltaic systems, it can be pointed out that generation corresponding to the demand should preferably be chosen near the coast. The advantage of higher irradiation in desert regions that are far away from the coast is offset by the cost of additionally required transmission lines. However, CSP power plants require higher direct normal irradiance (DNI), but can improve the capacity utilization of the transmission systems by having more full-load hours. Thus they are able to finance the transmission costs. Wind turbines find very different wind conditions in North Africa. Here the site selection strongly depends on the wind speed and the site conditions. Sites in Morocco and Egypt are especially profitable.

The hourly production on the basis of operation optimization of all power plants shows characteristic patterns:

- High share of wind power generation due to cost advantages compared to all other technologies, but with strongly fluctuating production profiles.
- Photovoltaics covers a large share of daytime power supply requirements.
- Solar thermal power plants are especially needed to meet demand in hours with little wind generation and without sunshine (late afternoon and at night).
- Conventional power stations are needed at night for the supply of electricity, since PV power plants do not generate any electricity then.

Chances for the integration of renewable energy in the international transmission grid

3.2.2.2 Regional power exchange: impact of current exports

The individual regions in North Africa will develop very differently in the future regarding electricity import and export into the respective neighbouring regions. Depending on the irradiation conditions and the wind supply, the electricity exchange is highly variable. Individual regions play a very important role within the national electricity supply because of their wind supply.

In scenarios with electricity export, higher shares of generation are shifted in all countries towards more northern regions with access to Europe. Only in Egypt are the shares of direct exports to Europe low due to the distance. Depending on solar radiation and wind conditions, the exchange of electricity between regions can fluctuate greatly.

3.2.3 Expansion of grid capacities and challenges

A detailed analysis of the existing transmission grid and the expansion needs were carried out on the basis of regional production and demand profiles (see Chapter 3.2.2).

3.2.3.1 AC transmission grid

In a first step, the existing AC transmission grid structures for EU-NA were analysed and simulated in a model. The affected grid regions, synchronous zones, interconnectors and DC connection points were integrated according to the current planning status. The result of this modelling is an AC transmission grid infrastructure for Europe and North Africa (see Figure 3-7) including the geographical topologies and the physical properties such as transmission capacity, voltage levels, cable lengths and line impedances. This model forms the basis for the subsequent grid expansion considerations.

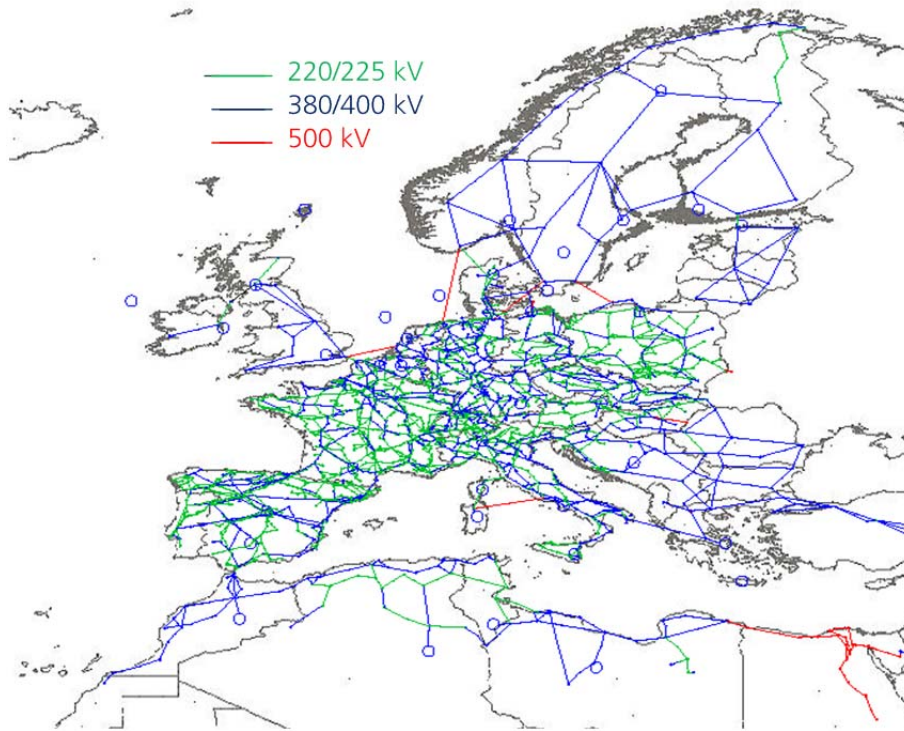

Figure 3-7: Modelled AC transmission grid in EU-NA by voltage level

The time series of the generation in each region from the previous power plant planning was transferred to the grid model for a detailed analysis of the resulting grid flows. This approach made it possible to successively determine the grid expansion of the AC transmission infrastructure. Initially a rudimentary HVDC power grid by CIGRE [7] supported the power transmission between NA and EU, in order to manage the predicted transmission performances for 2050. Grid expansions according to criteria of the expansion planning [8] (N-1 criterion, voltage stability, static stability, etc.) were taken into account.

The determined expansion requirements for the four scenarios examined in comparison with the present state (status quo) are shown in Table 3-5.

Table 3-5: AC expansion requirements for the four scenarios

Scenario	TTC [MVA]	Need for Expansion	Total Length [km]	Additional construction [km]
Status Quo	390,184	-	24,320	-
Scenario 1	801,840	206 %	69,680	45,359
Scenario 2	919,690	236 %	87,589	63,269
Scenario 3	2,805,746	719 %	310,580	286,260
Scenario 4	2,696,822	691 %	290,886	266,566

A grid expansion to about two times (for the scenarios without electricity export to Europe) and seven times the size (for the scenarios with current exports) appears enormous and very ambitious.

The general disadvantages of AC transmission over long distances, however, remain

and will be aggravated by the transfer of volatile renewable energy. Despite grid expansion, the AC transmission will be inefficient due to high reactive power consumption and low line utilization (Table 3-6).

Table 3-6: Line utilization and reactive power consumption for the four scenarios

Scenario	Average line utilization [%]	Median ratio of Q/P	Max. Q/P (individual connections)
Scenario 1	21.4 %	4.47	69
Scenario 2	21.5 %	1.48	12
Scenario 3	27.7 %	2.07	37
Scenario 4	31.0 %	2.06	56

3.2.3.2 Development of a HVDC overlay grid

As an alternative to AC grid development, the establishment of an inter-continental transmission system in the form of a high-voltage direct current (HVDC) grid for Europe and North Africa has been analyzed and evaluated in a further step.

This modelled and proposed HVDC grid is an overlay HVDC grid. An overlay grid is used to lighten the load on the underlying grid for electricity transmission. In our case, the overlay grid is used to relieve the subordinate AC power grid when large quantities of power are transported over long distances. The overlay grid is designed as an HVDC grid, which offers additional advantages in terms of long-range power transmission, wiring and environmental aspects. The HVDC grid was developed in meshed form, based on a CIGRE Grid Feasibility Study [7] and provides multiple redundant paths for the electricity transmission. This results in advantages for the safe transmission and transfer of volatile power flows from renewable energy and rapidly fluctuating spatial allocation of production and consumption.

The HVDC grid model takes into account the results of the long-term modelling of Chapter 2 (see Figure 3-8).

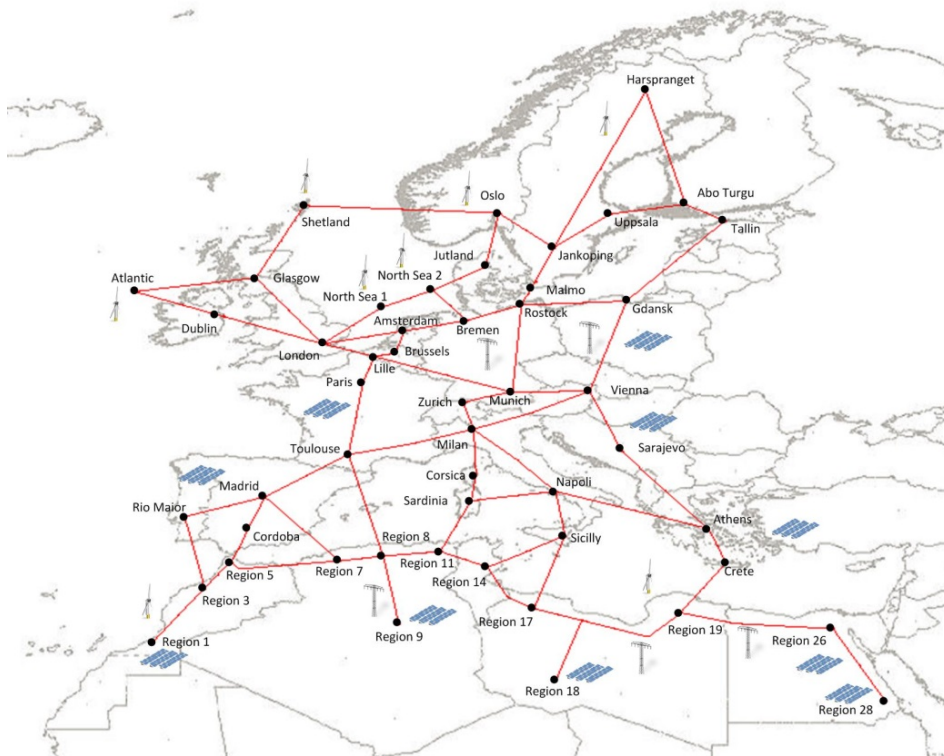

Figure 3-8: Proposed inter-continental European-North African HVDC overlay grid

For the grid implementation, the following assumptions are made in the model:

- Use of Voltage Source Converter (VSC) inverter technology
- Bipolar configuration with ± 800 kV
- Meshed HVDC grid topology

Based on these assumptions, the operation of inverter terminals can be switched from feed-in to feed-out. The operation and the safety of such a grid still require new components and operation management methods, since such a meshed HVDC power grid does not yet exist today (see section 4.1) [9].

Using the example of Morocco, the consequences of grid expansion are illustrated. The basic grid represents already the version planned for 2020, which is planned for 42% RES and thus represents a very high extension standard. The results show that the grids will be sufficient until 2030 for the scenarios without export options, and only a few new lines are required by 2050. However, scenarios with electricity export need about 1.6 times the grid capacity along the existing transmission lines. A proposed HVDC overlay grid [10,11] on the other hand connects regions of large generation with the points of high power demand (Figure 3-9).

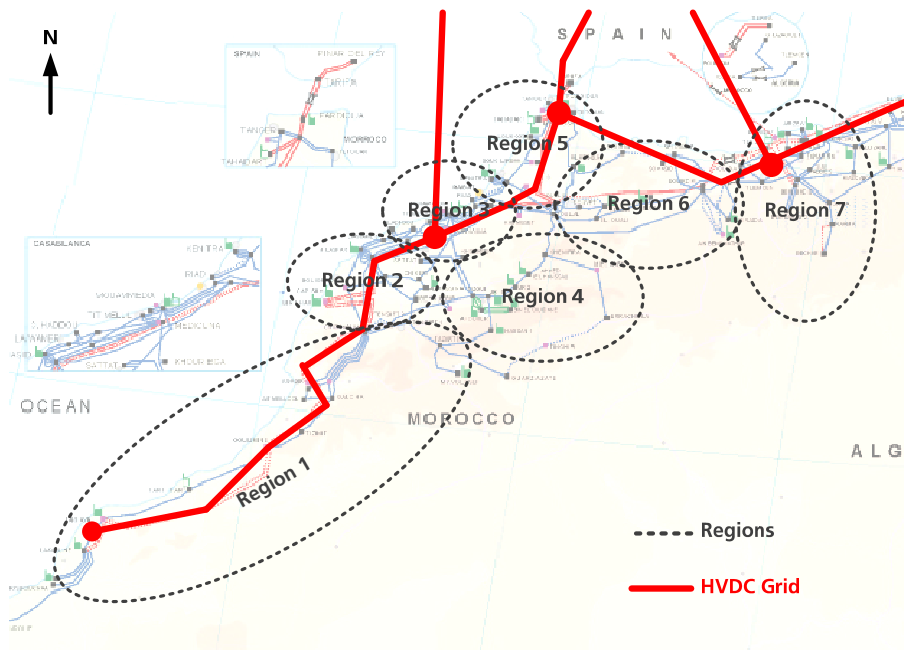

Figure 3-9: Proposed HVDC grid in Morocco (Edited extract, original from AUPTDE [6])

3.3 Conclusions

The results of the modelling of all scenarios show that decarbonisation of the electricity systems in the EU and NA on the basis of RES is possible and economically practicable. High proportions of RES can be achieved in each scenario by 2050 - in the politically most ambitious scenario 3 almost 100%. The substantial potential in NA can be developed at relatively low costs and in particular allows export of renewable electricity to Europe after 2030. Here, wind energy dominates until 2030, being very favourable in good locations, followed by PV and CSP. CSP with thermal storage plays a special role as a balancing power in grids with high RES shares and offers the perspective to replace conventional power stations such as gas power plants.

The regional distribution of renewable electricity generation depends on geographical location conditions, irradiation and wind potentials as well as the distance to the demand centres. While wind is generated mainly in coastal regions, PV is used on a distributed basis with a wide spatial coverage; the CSP sites require high direct-radiation potentials.

In each scenario, a strong expansion of RES would bring huge extensions of the AC transmission grid. In the cases of exports to Europe, this represents an option which is almost prohibitive, requiring an eightfold increase of the cable lengths. A solution would be to install a meshed superimposed HVDC grid with bipolar VSC technology which allows the transmission of fluctuating power from renewable power plants over long distances.

This expansion implies substantial technological and political challenges. Particularly suitable HVDC operational strategies need to be developed and evaluated in detail. For this, intensive cooperation with the transmission system operators is necessary (see Chapter 4).

Corresponding transformation paths for the energy systems require regulatory and policy frameworks that need to be developed in a political dialogue between the participating countries (see Chapter 5).

Further publications:

- ❖ S. Bohn, M. Agsten, I. Boie, C. Kost, O. Snigoviy, A.-K. Marten, D. Westermann: »*Meshed HVDC Transmission in the Context of Sustainable Power Transmission for the Future and its Environmental Impact*«, Journal of Strategic Innovation and Sustainability, Vol. 10 (1) 2014, pages 88-97, ISSN 1718-2077
- ❖ I. Boie, M. Pudlik, M. Ragwitz, F. Sensfuß, S. Bohn, M. Agsten, P. Bretschneider, D. Westermann: »*Scenarios for Renewable Energy Deployment in North African Countries and Electricity Exchange with Europe – A Model-based Analysis for 2050*«, International Journal on Smart Grids and Clean Energy (SGCE), Vol. 3, No. 3, July 2014, pp 299
- ❖ S. Bohn, I. Boie, C. Kost, M. Agsten, D. Westermann: »*SuperGrid – Das europäisch-nordafrikanische HGÜ-Overlay-Netz der Zukunft*«, Conference proceedings Internationaler ETG-Kongress 2013 – Energieversorgung auf dem Weg nach 2050, Berlin, Germany, ETG-FB 139, ISBN 978-3-8007-3550-1
- ❖ C. Kost: »*Renewable Energy in North Africa – Modeling of future electricity scenarios and the impact on manufacturing and employment*«, Dissertation TU Dresden, June 2015

Chances for the integration of
renewable energy in the
international transmission grid

4 Technological developments for the integration of renewable energy into the international transmission grid

Technological developments for the integration of renewable energy into the international transmission grid

4.1 Operations management and stability of new grid structures

According to the results of Chapter 3, it is reasonable to use an HVDC overlay grid on top of a developed AC grid. This grid should not consist of point-to-point connections, but should be meshed. The use of bipolar VSC HVDC technology enables the creation of a grid which can integrate electricity from fluctuating renewable energy and volatile power flows. Since such meshed HVDC grids do not yet exist, a holistic approach requires investigations of grid operations management. Figure 4-1 serves as a process model.

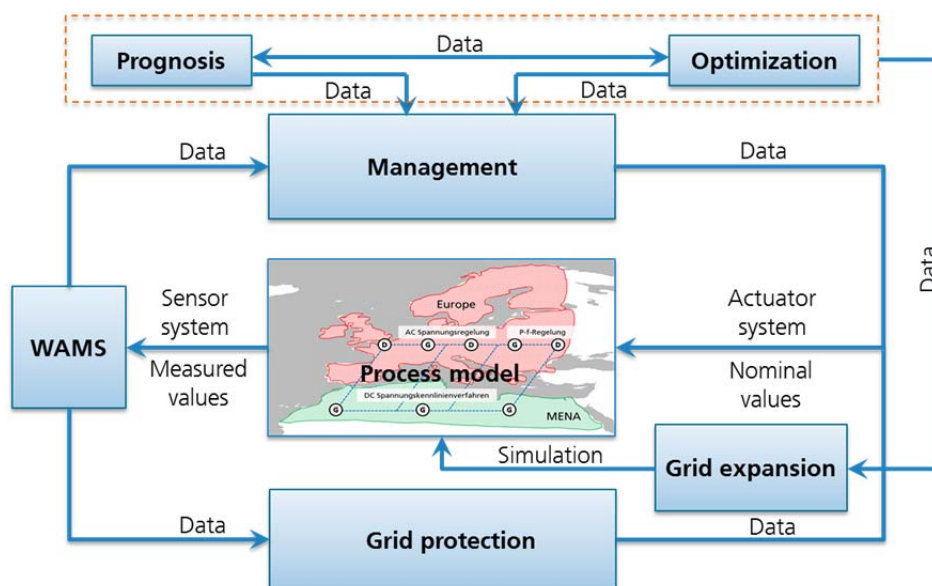

Figure 4-1: Process model for grid expansion, grid management and grid protection

Based on the existing AC transmission grids in Europe and North Africa as well as the predicted amount of energy, an inter-continental European and North African transmission infrastructure has to be developed. This needs to be consistent with forecasts and optimized electricity generation, taking into account also grid protection, to allow safe and efficient energy exchange.

4.1.1 Grid operation and grid stability

Thus, the HVDC operations management for the meshed grid uses a newly developed, distributed voltage characteristics method [12] and is capable of transferring rapidly fluctuating renewable energy. Ensuring reliable grid operation is the top priority of grid management and is part of the so-called system responsibility of a grid operator for the highest grid level. With the establishment of an HVDC grid, a grid level is created that can make a significant contribution to grid stability.

In contrast to AC systems, in which system frequency can vary due to a performance imbalance of the system, there is no system frequency in direct current systems. Instead,

the DC voltage may be used as a reference. This requires a decentralized control procedure that operates independently of a fast communications infrastructure. The voltage characteristics method is based on the control of the current or power as a function of the measured DC voltage at each node and is embedded in the overall management (Figure 4-2).

Technological developments for the integration of renewable energy into the international transmission grid

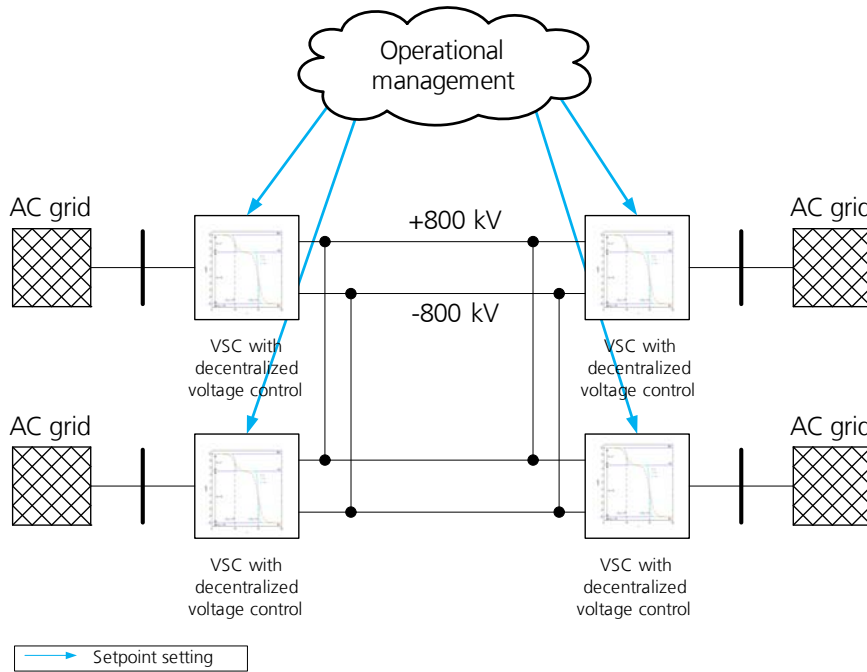

Figure 4-2: Abstract representation of the grid management process

4.1.2 Grid protection and grid security

At present, there is no experience in grid protection for meshed HVDC grids. However, the HVDC grid must be equipped with grid protection devices that can control relevant incidents and load cases. Due to the lack of phase information, its grid protection differs from that of an AC grid.

The central goal of power system protection is to protect equipment against overcurrent and other inadmissible stresses and to prevent the spread of the fault condition in the grid [13] (Figure 4-3). This includes the detection and localization of the fault condition and the initiation of appropriate measures of fault correction.

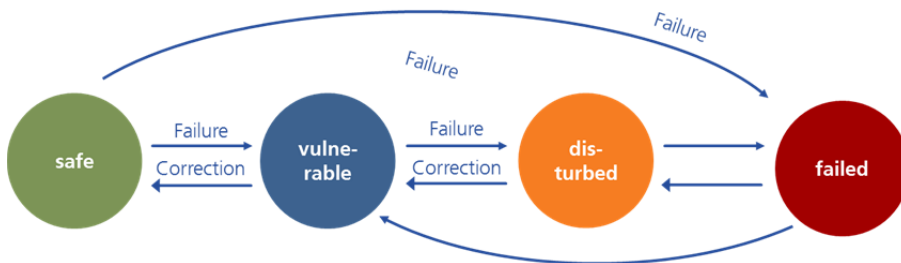

Figure 4-3: States of electric power supply systems

The evaluation of the grid status is made using protection criteria. These are physical quantities obtained directly by measuring devices from the grid or calculated from these. A fault is detected when predefined thresholds of these criteria are exceeded or

are below the limit values. In the HVDC system, feasible protection criteria include currents, voltages, impedances, power and differential variables. To ensure the reliability and speed criterion, special emphasis was placed on criteria that require only one measured quantity to avoid dependence on several different measuring devices. Possible indicators include system currents and voltages as well as their differential values that are exclusively taken into account in this work. The use of a parallel communication system is ruled out for the same reasons of reliability and speed.

Technological developments for the integration of renewable energy into the international transmission grid

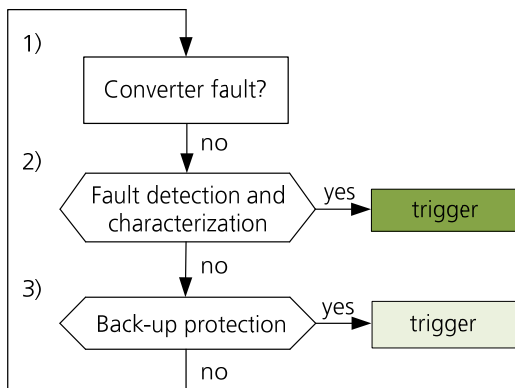

Figure 4-4: Algorithm for the detection of DC line faults

A detection algorithm based on differential quantities derived from current, voltage and ground current slope is continuously performed for each node. A continuous evaluation of the fault condition is thus possible as well as localization of the fault. This represents a first step towards the realization of a safe DC grid (Figure 4.4, see also [14] and [15]).

Further publications:

- ❖ S. Bohn, M. Fetisova, M. Agsten, A.-K. Marten, D. Westermann; »A continuous DC voltage control function for meshed HVDC grids, and the impact of the underlying future AC grid due to renewable in-feed«, 6th IEEE International Conference on Modelling, Identification and Control (ICMIC2014), Melbourne, Australia, Dec. 2014
- S. Bohn, J. Kayser, M. Fetisova, A.-K. Marten, M. Agsten, D. Westermann; »The Operation of a Meshed HVDC Grid – A Model-based Analysis of a Supergrid«, Australian Utility Week, Melbourne, Australia, Nov. 2014

4.2

Development of components for medium-voltage systems

Technological developments for the integration of renewable energy into the international transmission grid

A key technology for the development of future grids is power electronics. Due to the growth of renewable energy, the number of power electronic converters is increasing. With the increasing share of wind power and photovoltaics, the demand for high-efficiency inverters is growing for power distribution within the large-scale power plants at the medium-voltage level. They are intended to keep the line losses at high power as low as possible. At the same time, the importance of DC transmission grids and the interfacing with different producers, consumers and storages is growing.

Within the project, new solutions have been identified to meet the requirements of highly efficient power electronics for medium-voltage applications.

The main components in a power electronic system are semiconductor power switches and passive components such as filter chokes or capacitors. By developing a medium-voltage DC / DC converter, Fraunhofer ISE was able to demonstrate the potential of new high-voltage transistors made of silicon carbide (SiC). Concerning passive components, capacitors are constructed according to the state of the art of metallized polymer film winding. Due to the high currents and internal losses, thermal management of these components is critical, which is why glass capacitors have also been studied in SUPERGRID (see Chapter 4.2.3).

4.2.1 New PV power plant structures

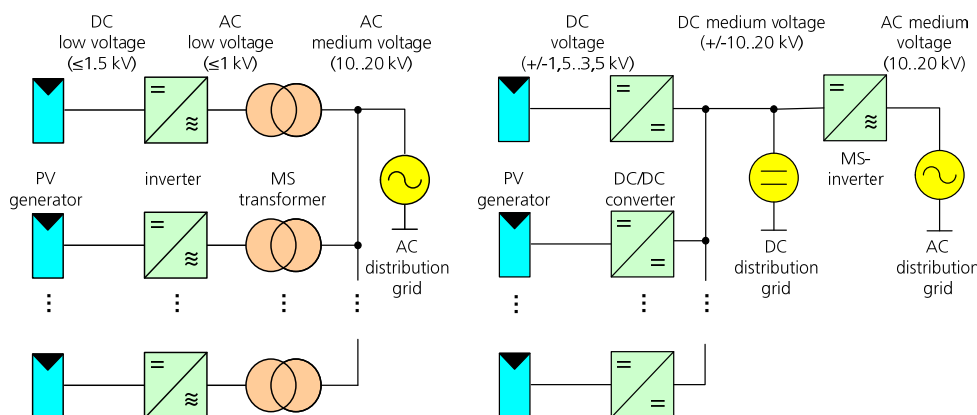

Figure 4-5: Left: Power plant structures of present large-scale PV power plants; Right: Possible structure of a PV power plant with medium-voltage DC distribution

Depending on the size of a PV power plant in the future, its sub-units, consisting of solar modules, inverters and a medium-voltage transformer, can be on the order of up to 2 MVA. This means that the currents on the low-voltage side are in the range of up to 3 kA - 4.5 kA, which results in large current-dependent heat losses (I^2R). The high currents also lead to high material costs due to the need for large-diameter copper wires in cables and transformers. In addition, technical management of these high currents becomes increasingly difficult and limits the size of the structural sub-units. In particular, for large power plants, it would be economically advantageous to build larger sub-units with 5 -10 MVA. However, this is only possible if the system voltage within the subunit is also increased. Then the sub-units can be dimensioned larger, so the number of system components is reduced considerably.

The comparatively low DC voltage within today's power plants is based on the 1000 V DC system voltage for PV modules which has been the maximum available to date. In the long term, up to 3.5 kV DC can be expected in the system. This means that there are indications of a technical systemic change. Instead of distributing the electric field by several parallel inverters and low AC voltage with high currents, future power plants could work with distributed DC / DC converters and high voltages. This could be the

basis to feed directly into the medium-voltage grid with a medium-voltage inverter without a transformer. In this case, several tons of copper and iron for a 50 Hz transformer would be saved.

Technological developments for the integration of renewable energy into the international transmission grid

4.2.2 Medium-voltage power electronics

Semiconductor devices of SiC have a very high potential for future applications in power electronics for medium voltage. The excellent electrical and thermal properties of the semiconductor material enable the production of low-loss transistors with reverse voltages of 10 kV and also much higher in the future. Such high voltages cannot be achieved with conventional semiconductor devices made of silicon. Transistors of silicon with fast cycle times are available only up to 6.5 kV. In order to achieve the same inverter voltage, significantly simpler topologies can therefore be used with SiC.

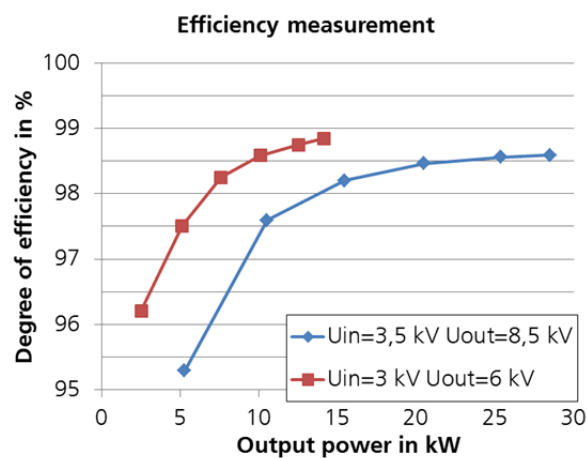

Figure 4-6: Left: Medium-voltage DC / DC converter, Right: Efficiency of the converter

Prototypes of 10 kV 10 A SiC MOSFETs were used for the project. First, a laboratory environment for medium-voltage testing was established, in which these components could be characterized in detail. Both very low on-state and switching losses of the SiC semiconductor were determined by measurement.

As a demonstrator, a DC / DC converter for an input voltage of 3.5 kV and an output voltage of 8.5 kV was developed. With a ground symmetrical interconnection of two of these transducers, an output voltage of 17 kV can easily be achieved, which could be fed directly into a 10 kV AC grid.

Due to the low losses of the SiC semiconductor, a switching frequency of 8 kHz was chosen. This corresponds to approximately 10 times the value of comparable medium-voltage converters of silicon semiconductors. The higher the switching frequency, the smaller the passive components can be dimensioned, which leads to savings of material, volume and cost. In operation, a very high efficiency of 98.5% was achieved at the rated power.

In the future, the Fraunhofer ISE will continue to drive forward the development of power electronic solutions with SiC devices for medium voltage. In addition to the use in regenerative power plants, further possible applications include grid stabilization or railway technology.

4.2.3 Glass film capacitor

Since conventional film capacitors are beginning to show their limits, an alternative material is required in the long term. Film capacitors are presently constructed of metallized polymer film windings. Due to the high currents and internal losses, thermal management of these components is critical. In addition, the capacitors represent a very

high percentage by volume in an inverter. By increasing the energy density and thus reducing the volume of the component, space and costs can be saved in the future. The glass manufacturer, SCHOTT, manufactures an alkali-free thin glass, which is suitable as an alternative dielectric. This is due on one hand to its excellent electrical properties and on the other hand to the possibility of manufacturing the glass to be very thin.

The relative permittivity of the glass is twice as large as that of the standard material polypropylene and the breakdown field strength is approximately one order of magnitude higher, thus being one of the highest ever measured. Both values are essential for the calculation of the theoretical energy density and they therefore determine how small a capacitor with certain electrical specifications can be built. The breakdown field strength is squared, whereby the energy density increases strongly, especially in high-voltage applications. Figure 4-7 shows an overview of various dielectrics and their electrical properties, as well as the theoretical energy density. The glass is manufactured via a drawing method from the melt, the so-called down-draw method. Thus, very thin glass (<25 micrometres) can be manufactured, which behaves flexibly. In the future, it will be possible to process glass film in roll-to-roll processes analogously to polymer films. This allows a cost reduction in the manufacturing and the use of standard manufacturing processes for polymer film capacitors.

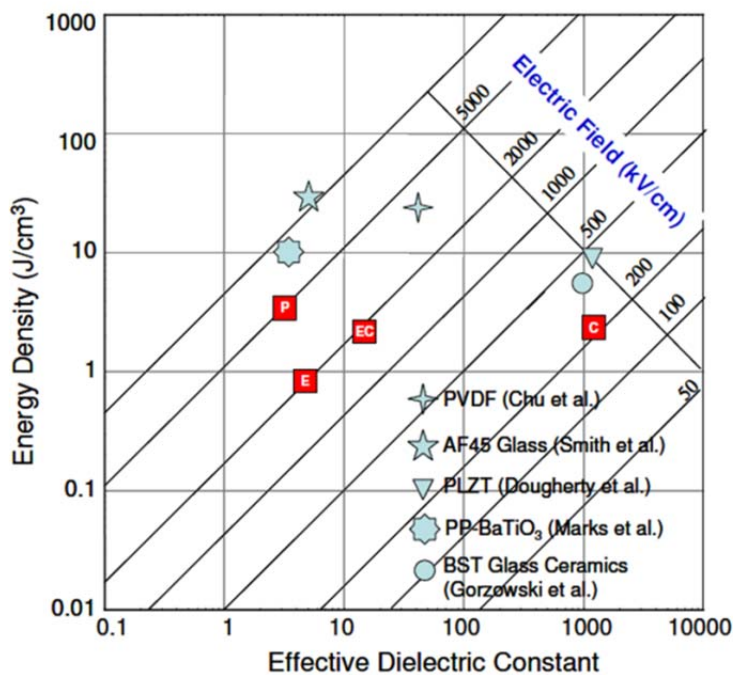

Figure 4-7: Properties of glass ceramics for capacitors (after [16]).

One aspect of the project at Fraunhofer IISB was the construction of test capacitors of the described dielectric to show that the theoretical values of the dielectric can also be applied to the component level. Test batches of glass plates were thereby constructed (Figure 4-8) with capacities of approximately 25 nF with a breakdown voltage of max 8.5 kV. This corresponds to slightly more than half of the theoretical maximum of the glass.

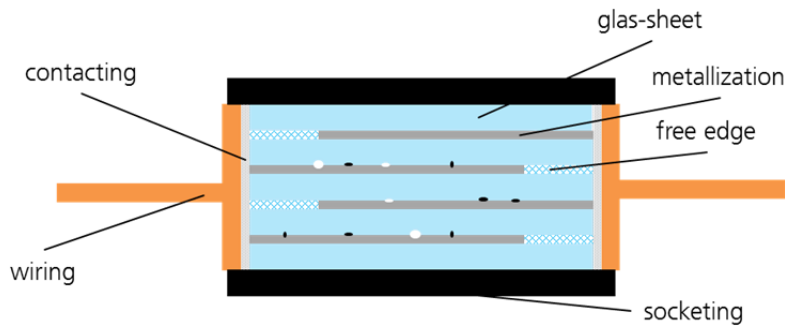

Figure 4-8: Schematic representation of the built-up capacitor stack

In the project, a conventional capacitor for a DC / DC converter was required, which could be replaced in the future by a new technology. The standard capacitor, which allows a DC electric strength of 8 kV at a capacity of 1 μF , has a volume of about 685 cm^3 . A capacitor made of the thin glass film would have a volume of 200 cm^3 , including a safety factor of 2 (e.g. for housing, connection technology ...). This corresponds to a volume reduction of about 70% compared to the current standard technology. In the long term, a volume reduction by a factor of 10 could be possible.

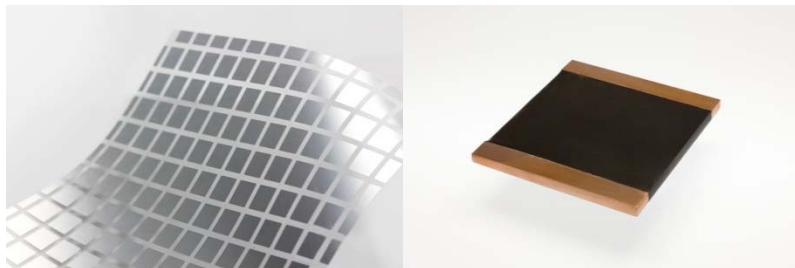

Figure 4-9: Metallized thin glass film (left) and assembled capacitor (right)

During the project, a functioning capacitor with high energy density was produced from the thin glass (Fig. 4-9). Furthermore, it was shown that typical process steps of existing film capacitor technology can be transferred to the new material.

- The coating of the glass with various metals is easily possible by vapour deposition.
- The standard method for contacting film capacitors (Schoopering - a flame spraying method) is also possible

Since this is a very new material that is very different from the materials used previously in capacitors, further work is planned to show that its potential can be exploited beyond the laboratory scale. To achieve this, the construction technique of the capacitors must be further optimized. In further steps, the electrical performance and service life must be evaluated.

Further publications:

- ❖ J. Thoma, D. Chilava, D. Kranzer; »A Highly Efficient DC-DC-Converter for Medium-Voltage Applications«, IEEE International Energy Conference, Dubrovnik, 13th-15th May 2014; 2014.
- ❖ N. Tham; T. Erlbacher; »Capacitors with High Energy Density«, ECPE Workshop Innovations in Passive Components for Power Electronics Applications, 2014 Berlin.

4.3

Thermal energy storage for CSP power plants

It is generally assumed that solar thermal power plants with thermal energy storages (TES) and as hybrid power plants have significant advantages over fluctuating sources due to the controllability of generation. Therefore, the high-temperature storage development is considered to be central by the industry. Another trend towards higher operating temperatures (molten salt as the heat transfer medium) can be seen. In both approaches, molten salts (nitrates, nitrites, etc.) and their interaction with structural materials (e.g. different steels) play a key role. Decisive issues are therefore:

- Cost reduction due to cheaper storage materials and more efficient systems
- Freeze prevention and higher temperature stability
- Thermo-mechanical design and durability of components in the circuit
- Techno-economic optimization of the overall system concepts including management

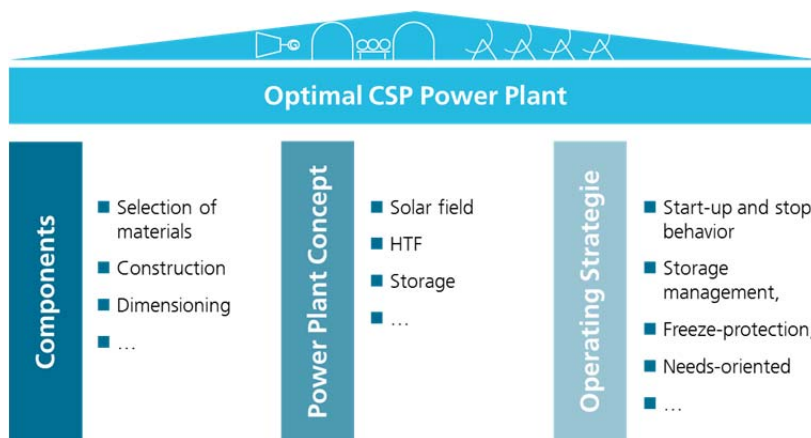

Figure 4-10: Influential factors in the optimization of a solar thermal power plant

To identify concepts with a high potential for cost reduction, the storage options must be considered in the context of the system. Simulation is a suitable method for this purpose. The dependence on the season and weather, the partial load behaviour, the transient states and the management of the complete system should be modelled dynamically. Within the SUPERGRID project, a validated simulation platform was created with extensive models for concentrator and receiver technology, heat transfer medium and storage types. In particular, two-phase direct evaporation and molten salt systems (line-focusing collector arrays and solar towers) can be mapped in detail. Cost models have also been implemented to run techno-economic optimizations.

4.3.1 State of technology

Today, commercial solar thermal power plants with TES use indirect or direct two-tank molten salt storage - depending on the heat transfer medium, oil or molten salt. Storage that enables isothermal heat transfer, as would be thermodynamically optimal for direct evaporation, are at best available as expensive demonstrators. A further development of storage technology using storage materials at the lowest possible costs is urgently needed. Cost reduction is possibly achievable by the use of waste material or salt with lower purity. A cost evaluation of new concepts must be carried out systematically on the basis of simulations to be able to develop the technology in a target-oriented manner.

4.3.2 Optimization of CSP plants with high-temperature storage

Different storage concepts have been modelled and simulated for systems with thermal oil, molten salt or direct steam as a heat transfer medium in the solar field [17–20]. Line-focusing collectors are described as examples below (Table 4-1). An extension of the methodology towards tower systems is on the way. The question of the optimal storage is strongly linked to the selected heat transfer medium. Operations management, the need for heat exchangers, temperature gradients and maximum operating temperatures also affect the cost optimization of the storage concept. The direct storage concepts use the heat transfer medium also as a storage material; for indirect storage, another material is selected. The cost aspect is dependent on the number of heat exchangers and the temperature and fluid-related material selection. Cost models must therefore also be considered.

Table 4-1: Example of simulated system concepts

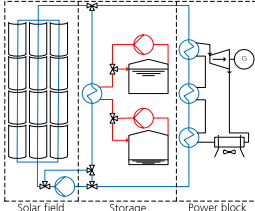
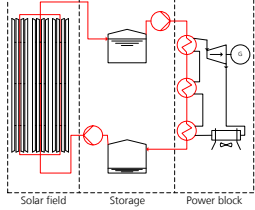
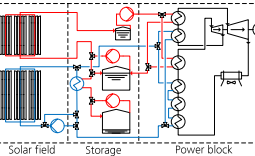
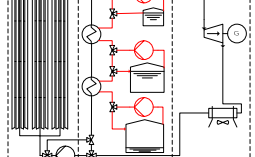
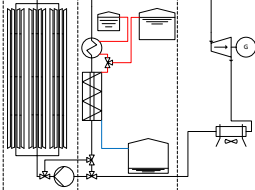
<p>A) CSP system with indirect 2-tank molten-salt storage Andasol configuration</p>		<p>WTF: thermal oil Storage medium: 60 % NaNO₃ 40 % KNO₃ Storage capacity: 1000 MWh_{th} Power block: 50 MW_{el} Solar field outlet temperature: 396 °C Storage temperature: 386 °C / 296 °C</p>
<p>B) Fresnel system with direct 2-tank molten-salt storage</p>		<p>WTF: molten salt Storage medium: as in SF Storage capacity: 1000 MWh_{th} Power block: 50 MW_{el} Solar field outlet temperature: 550 °C Storage temperature: 550 °C / 290 °C</p>
<p>C) Fresnel system with indirect/direct 3-tank molten-salt storage Dual-loop</p>		<p>WTF: thermal oil + molten salt 290 °C -> 396 °C (thermal oil) 386 °C -> 550 °C (molten salt) molten salt storage: 550 °C 386 °C 296 °C</p>
<p>D) Fresnel system with indirect 3-tank molten-salt storage DSG</p>		<p>WTF: water/steam 3 molten-salt storage tanks: 550 °C 386 °C 296 °C</p>
<p>E) Fresnel system with indirect sensible / latent molten-salt storage DSG</p>		<p>WTF: water/steam Storage medium: NaNO₃ Storage capacity: 1000 MWh_{th} Power block: 50 MW_{el} Solar field outlet temperature: 520 °C at 110 bar Storage temperature: 500 °C / 295 °C</p>

NB: WTF: Heat transfer fluid; DSG: Direct Steam Generation; DMS: Direct Molten Salt

4.3.2.1 Results

The annual continuous characteristics of various power plant storage combinations are shown here to demonstrate the different operating states of power plants. All power plants with cost-optimized solar field sizes have 1000 MWh_{th} molten-salt storage and a 50 MW_{el} power plant unit in common.

Technological developments for the integration of renewable energy into the international transmission grid

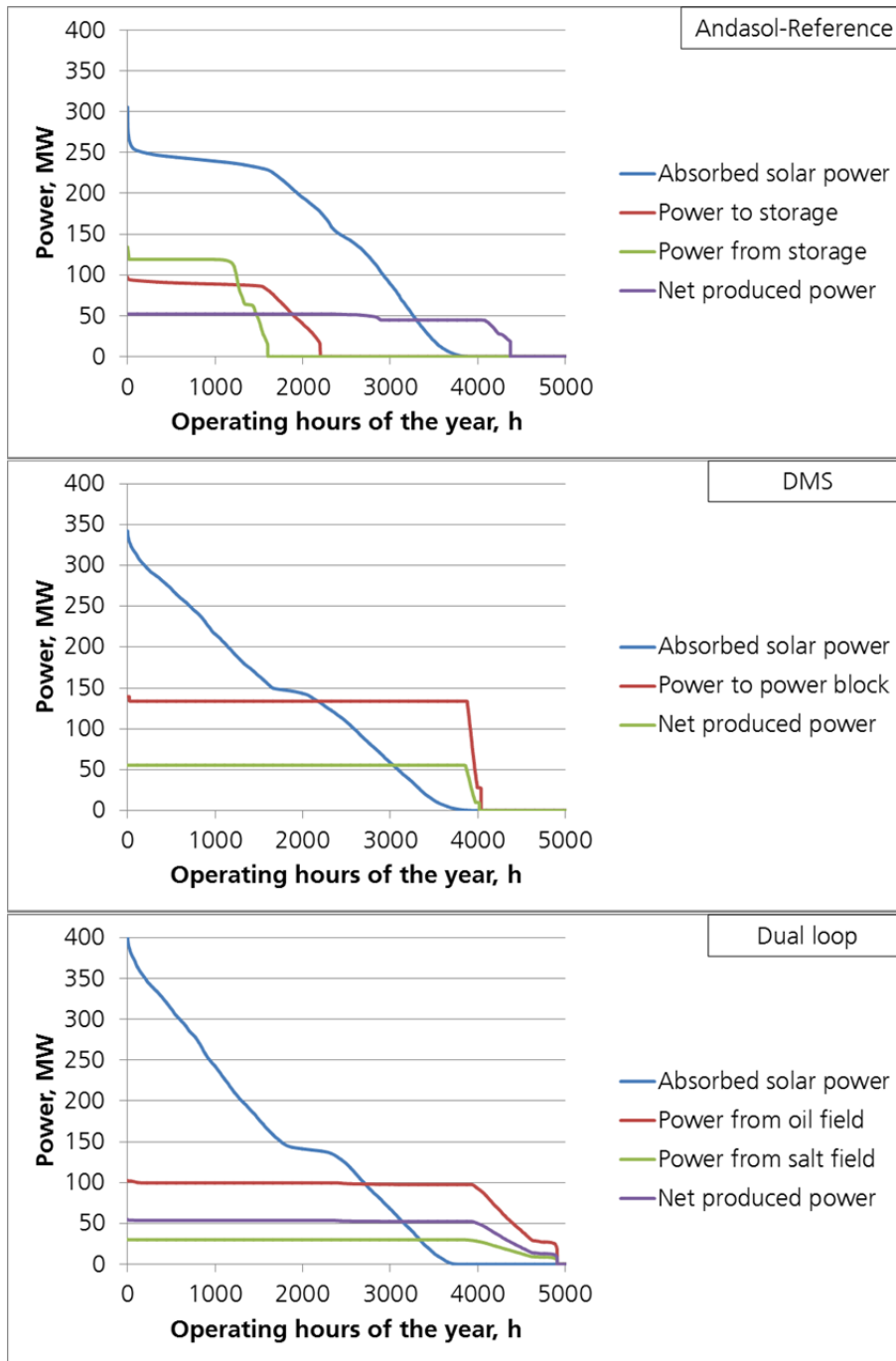

Figure 4-11: Performance of various power plant configurations versus annual operating hours: System A (top), System B (middle) and System C (bottom)

Not all configurations can completely exploit the radiation potential. Direct storage systems with a large temperature spread are preferable. They are the best option with regard to energy and usually allow easy and flexible system integration. The power

block can be completely decoupled from the operation of the solar field. Two-tank systems have one of the best efficiency values in the field of thermal storage. The connection with the heat transfer fluid, the corrosion of materials of construction and the prevention of freezing is important. Cost-optimized concepts are possible only by holistic optimization.

Direct-evaporation collectors using water as the fluid are preferable from the viewpoint of environmental risks. These collectors have advantages also in the use of steam in industrial production. A thermodynamically optimal storage could be a phase-change storage medium which melts in the appropriate evaporation region (pressure rate). The concept of a screw heat exchanger has also been examined in the project, giving hope for reduction of the previously very high costs.

The storage costs can be reduced also with a thermocline tank or a tank with an internal barrier. Here, the savings potential amounts to up to 34% if some of the expensive storage medium is replaced by less expensive fillers. The fillers must be stable in molten salt and must be available at sufficiently low cost. A design challenge which still remains is the prevention of so-called »thermal ratcheting«, the bulging of the tank wall by inelastic deformation due to different coefficients of expansion of fillers and tank wall material.

4.3.3 Reliability, safety and durability of thermal storage

Corrosive, thermal, mechanical and tribological loads, acting differently on the components, result from the interaction of corrosive and abrasive heat transfer fluids (WTF) and the metal construction components of CSP power plants. A method for determining the reliability should therefore identify the primary degradation mechanisms and the materials by adapted qualification tests, which also allow lifetime estimation. Figure 4-12 illustrates the methodological approach to evaluate thermal high-temperature storage and their components.

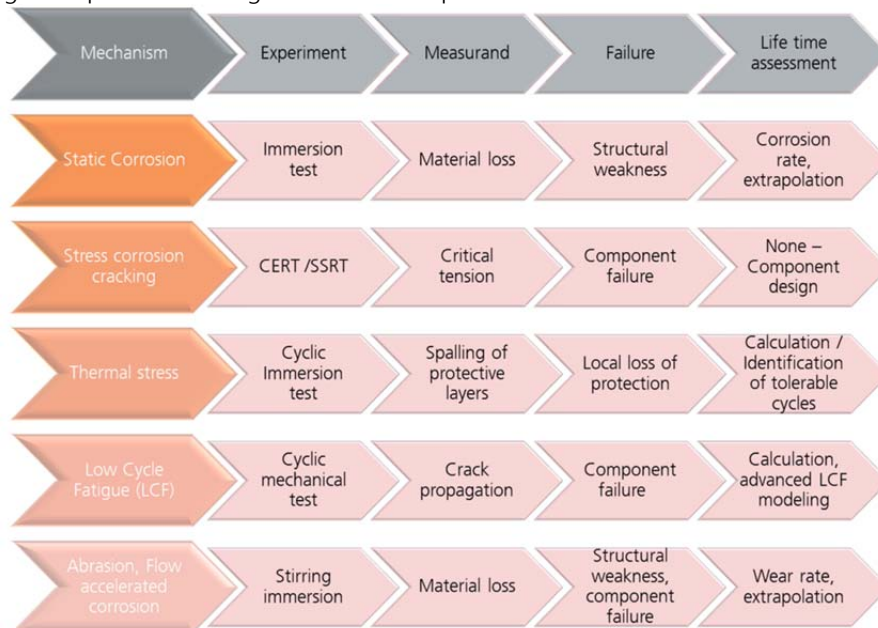

Figure 4-12: Methodology for determining the degradation mechanisms of materials for high-temperature storage.

Depending on the requirements of the various components (pipes, heat exchangers, pumps, etc.), tests were developed that could simulate the various loads [21]:

- Statistic corrosion test

- Test to stress corrosion cracking (CERT test - Constant Extension Rate Tensile)
- Low cycle fatigue test (LCF-test - Low Cycle Fatigue)
- Rubbing wear test (corrosion under load flow)

Technological developments for the integration of renewable energy into the international transmission grid

The tests can be adapted to specific demands of the application and are well suited for the qualification of materials that are in contact with hot, corrosive salts. In combination with studies of microstructural changes, the methods can be used in a combined analysis to determine degradation mechanisms and allow the derivation of predictions for component lifetimes. A good understanding of the degradation process and of model calculations for the description of stress corrosion cracking is necessary. Under LCF and TMF (thermo-mechanical fatigue)-stress conditions, cracks are formed early, where their growth is favoured by deposits of impurities in the crack tip. Figure 4-13 schematically shows the underlying mechanism for a continuous crack growth and the concomitant degradation of the components.

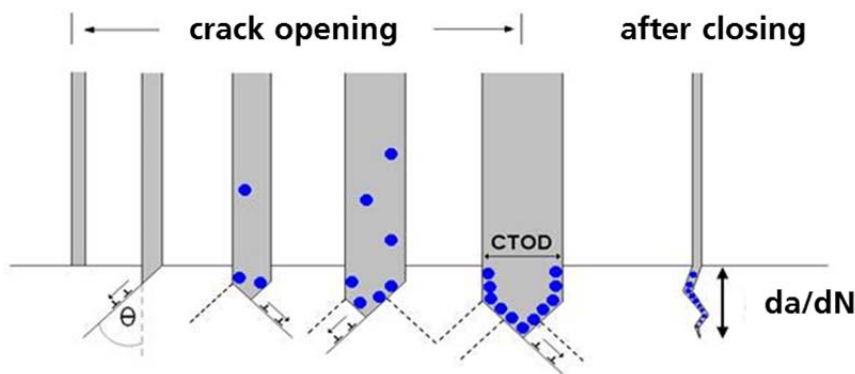

Figure 4-13: Mechanisms of stress corrosion cracking.

For the illustrative tests, two austenitic steels and one ferritic steel were used. Sample geometry and surface roughness were determined in the same way for each of the tests

Table 4-2: Chemical composition of the analysed steel types for corrosion tests.

Elements	347 Nb stab.	Sanicro25	T/P91 (X10CrMoVNb91)
C	0.026	0.1 max.	0.093
Si	0.22	0.2	0.4
Mn	1.88	0.5	0.55
P	0.009	0.025 max.	0.015
S	0.001	0.015 max.	0.003
Cr	18.45	22.5	9
Ni	10.80	25	0.36
Nb	0.35	0.5	0.07
W	-	3.6	
Co	-	1.5	
Cu	-	3	
N	-	0.23	0.056
Mo	-	-	0.93
Al	-	-	0.006
V	-	-	0.22

During static and cyclic testing, the austenitic steels, which are already used with CSP components, showed thermomechanical stability superior to the low-alloy P91 steel, also for an additional corrosion attack by molten salt.

During static exposure testing, a significant influence of the chemical composition of the molten salt on their corrosiveness was demonstrated by gravimetric analysis. Steels in »industrial-grade« molten salt, i.e. in melt with a significant percentage of chloride contaminants, corroded about 10 times faster than in "refined-grade" molten (chemically pure nitrate-nitrite mixtures). Furthermore, through the use of metallic multilayer coatings based on PVD, approaches could be identified on how, in principle, the corrosion rate of the analysed steels can be significantly reduced in the hot melt. In the case of corrosion without strong mechanical stress (tank walls), immersion tests show additional corrosion progress by contaminants in industrially purified molten salt. With newly developed coatings, cost-effective steels can also be protected for temperatures below 500 °C. Abrasion tests under conditions which are similar to those prevalent in a newly developed screw heat exchanger [19], however, showed that in this case cost-effective carbon steel is not sufficient, but that at least stainless steel must be used to guarantee durability.

4.4 Conclusions

With the use of bipolar VSC HVDC technology, an HVDC overlay grid can be laid on top of a developed AC grid. This new grid topology needs a holistic approach to grid management. The HVDC operations management for the meshed grid may be based on a newly developed decentralized voltage characteristics method. It seems possible to localize faults by using a fault-detection algorithm based on differential current, voltage and ground current

First steps in the development of medium-voltage DC / DC converters in the 10-20 kV range were taken. Fraunhofer ISE was able to demonstrate the potential of new high-voltage transistors made of silicon carbide (SiC). Concerning passive components, prototypes of capacitors based on thin glass films have been successfully tested. Further work is necessary to raise the voltage.

For the thermal storage systems, the dynamic system simulation platform has been extended to include a number of different storage models, thus making it possible to evaluate the performance in different power plant concepts. For the case of using molten salts for heat transfer and storage, the laboratory equipment to test the durability of steel components in the aggressive environment of hot salts has been greatly extended. Steel corrosion was shown to depend strongly on the chosen material quality and the contaminants in the salt. Thorough selection and quality control of materials is necessary for a commercial project.

A laboratory for testing storage prototypes has also been built and first experiments performed. Due to the large heat capacity of direct molten-salt storage tanks, relatively large amounts of energy can be stored at reasonably low cost. However, there is still potential to reduce costs further by using low-cost materials.

Further publications:

- ❖ K. Lovegrove, W. Stein (eds.); »Concentrating solar power technology: Developments and applications«, Cambridge: Woodhead Publishing Ltd; 2012.
- ❖ D. Laing, R. Tamme, A. Wörner, W. Platzer, P. Schossig, A. Hauer; »Thermische Energiespeicher – Neueste Entwicklungen und Anwendungen«, In: Proc. Jahrestagung Forschungsverbund Erneuerbare Energien 2012: Zusammenarbeit von Forschung und Wirtschaft für Erneuerbare und Energieeffizienz, 16-17 October 2012, Berlin; 2013.
- ❖ A. K. Vogel, H. Reiling, T. P. Fluri, W. J. Platzer, 2013: »Salzschmelzespeicher für Linear-Fresnel-Solarkraftwerke«, Kraftwerkstechnik, Band 5, TK Verlag Karl Thomé-Kozminesky, p. 695-712. ISBN 978-3-944310-04-6.
- ❖ M. Gurr, S. Bau, F. Burmeister, M. Wirth, E. Piedra, K. Krebsner, J. Preußner, W. Pfeiffer: »NiVAI multilayer coatings for corrosion protection of low-alloy steel in hot salt melts«, 14th International Conference on Plasma Surfaces and Engineering«, Garmisch-Partenkirchen 2014.
- ❖ E. Piedra, W. Pfeiffer: »Qualifizierung von Stählen für die Anwendung in Solarthermischen Kraftwerken – Eignungsprüfung für einzusetzende Materialien«, Konstruktion, 1-2, 2014.

5.1 Analysis of the regulatory framework in North Africa

Although many MENA countries have formulated ambitious goals relating to the expansion of renewable energy, there are deficits in the countries regarding the current market structure and grid regulation that slow down or even prevent the diffusion of technology. Common obstacles are, for example:

- Subsidies of fossil fuels, which constrains the competitiveness of the RES
- Lack of competition and obstacles to entry for RES in the electricity sector
- Grid congestion and unclear grid expansion concepts
- Unclear grid regulation and difficulty of access to the grid
- Lack of financing concepts for renewable energy expansion and lack of reliability of the renewable energy targets and promotion

Therefore, the regulatory framework of the countries examined in the project was evaluated and the promotion instruments (direct / indirect, based on investment, generation, price and/or volume) were compared in terms of their design elements such as target groups, project size, promotion rates and duration etc.. Further, their applicability in the region was studied. Due to different requirements, not all RES promotion schemes are equally suitable for the MENA countries. On the basis of this analysis, recommendations were derived (Figure 3-1). [1]

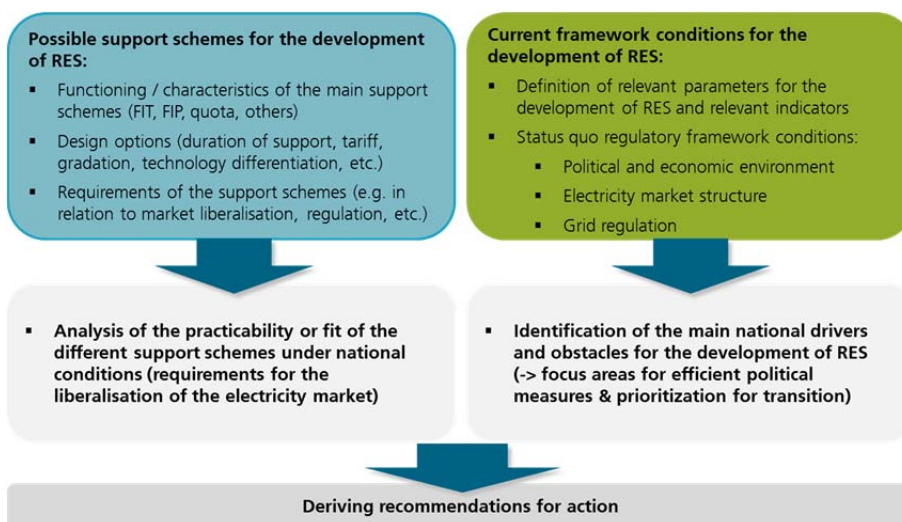

Figure 5-1: Classification in considering recommendations for action

5.2 Recommendations for future RES promotion schemes

In improving the regulatory framework for the expansion of renewables in MENA, priority should initially be given to the reduction of subsidies for conventional energy sources and the creation of fair and reliable market conditions for RE. Since long-term financing for the promotion of RES based on state budget or state funds is questionable, pay-as-you-go financing should be considered as a possible perspective.

The quota systems and the feed-in premiums place relatively high demands on the structure and the degree of liberalization of the electricity market. Therefore, this would

be more conceivable for MENA in the long-term perspective. Feed-in tariffs are most suitable on the short and medium terms to increase investment security and possibly to alleviate national risks, whereby initially feed-in tariffs and later feed-in premiums with a stronger market orientation are conceivable. The compatibility of RES promotion schemes varies greatly regarding the framework of incompletely liberalized electricity markets that prevail in many North African countries. The most limiting factors are due to the lack of marketing options for independent electricity producers and the lack of transparent reference electricity prices and the distortion of competition resulting from subsidies of fossil fuels. Furthermore, in particular the regulatory framework for grid access and grid development is partly not sufficiently well defined or is unfavourably designed so that both the large-scale production of electricity from renewable energy sources and the generation for self-consumption are not possible. Regardless of the chosen RES promotion scheme, the following framework should be created with the highest priority:

- Guaranteed grid access for independent electricity producers and prioritized access for producers of electricity from renewable sources.
- Clearly defined and transparent administrative processes for obtaining the necessary permits and grid access (with defined deadlines and maximum durations).
- Transparent and fair rules for the allocation of costs for the grid connection; Preferably, the electricity producer should only be charged for the connection to the nearest access node («shallow charging») and should not be charged for any necessary additional grid reinforcements.
- Priority supply of renewable electricity into the grid or, if limitation of RES power plants should be technically unavoidable, appropriate guaranteed financial compensation to the operators.
- Creation of cost-reflective and transparent electricity prices and reduction of subsidies in the fossil energy sector (especially on the production side).
- Separation of electricity production, transport and distribution.
- Transparent planning with centrally determined priority areas for the development of renewable energy.
- Creation of independent regulatory authorities to ensure fair competition in the electricity sector and to protect the consumers.

Phases are proposed for the establishment and development of renewable energy promotion schemes in the region (see Figure 5-2). A combination of the promotion with tendering models could be useful particularly in the initial stage because it facilitates the control of RES expansion and the promotion costs. The reliability and long-term nature of the framework for investors is decisive. Investment subsidies in the initial stage for more expensive RE technologies such as CSP make energy-political sense. »Net Metering« for RES self-consumption is recommended to reduce peak loads, relieve the grids and promote decentralized supply, if it is structured appropriately. With progressive liberalization of the electricity markets, more market-oriented instruments should be used.

On the medium and long terms, as soon as it is ensured that the national RES requirements to achieve the expansion targets of renewables can be met, the export of RES electricity to neighbouring countries and to Europe can play a role. For this purpose, in particular, the framework for the participation of independent power producers (IPPs) in export and the access to north-south interconnectors should be regulated. The national grid regulation should define grid access and transfer fees and also enable the independent power producers (IPPs) to participate. Long-term contracts for transmission rights via interconnectors, the combination of grid expansion with RES expansion and the possibility of privately financed transmission grids («Merchant Lines») also continue to support not only the export of electricity to

Europe, but also play a role for regional grid integration and the creation of RES business models at a national level.

As a longer term option, further high-level inter-continental (EU-MENA) harmonization of regulatory standards and far-reaching compatibility of North African RES promotion schemes with the promotion schemes in Europe could be envisaged. This would allow potential harmonization of RES promotion in the EU and MENA and could further simplify inter-regional trading of RES energy.

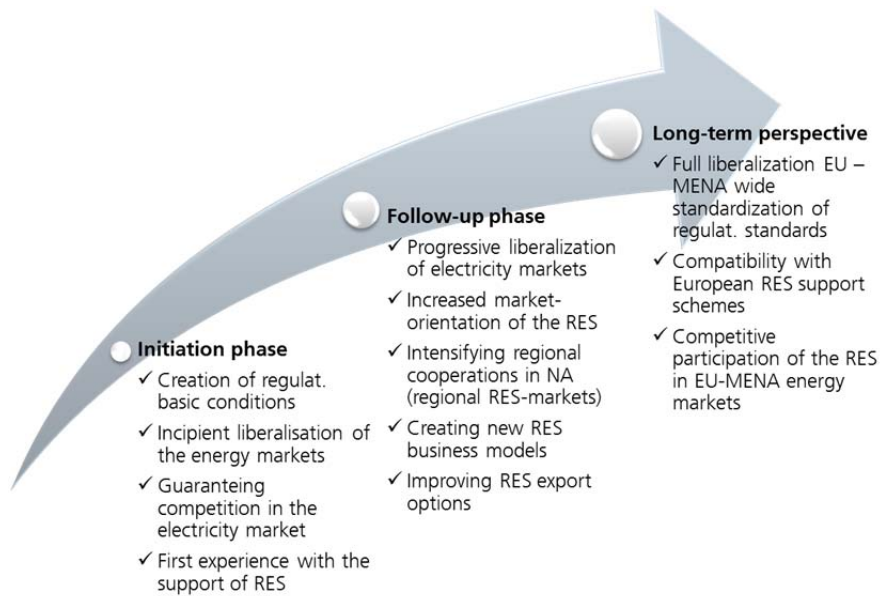

Figure 5-2: Recommendations for RES promotion in North Africa - Possible phases of the transition process

5.3 Conclusions

It has been shown by model-based analysis that there is great techno-economic potential for the use of renewable energy technologies in North Africa. The scenarios described here as examples for the region of North Africa show an ambitious expansion of renewable energy as well as ambitious developments with respect to future electricity exports to Europe. The status quo of the technological development in the countries studied, however, clearly shows that the high potentials alone are not sufficient for long-scale establishment of the relevant technologies.

Various obstacles, such as the competition-distorting subsidies in the conventional energy sector, the administrative barriers, the lack of availability of local value chains or the difficult conditions for RES project financing, delay or prevent the implementation of RES expansion.

Consequently, appropriate regulatory framework conditions and promotion schemes need to be established to enable the integration of renewable energy technologies in the corresponding national energy systems. It is necessary to accompany the development with efficient promotion instruments and adjustments to the regulatory framework to support the presented technological developments.

Further publications:

- ❖ I. Boie, M. Ragwitz, S. Steinhilber; »Promoting renewable energies in the MENA region: Regulatory developments and possible interactions with future EU support schemes for RES-E«, Conference Paper in Online Proceedings of the 14th IAEE European Energy Conference, Nov. 28-31st, 2014, Rome, Italy
- ❖ C. Kost, T. Schlegl, D. Möst; »Integration of renewable energies in North Africa to supply European electricity markets«, 13th European IAEE Conference 2013, Düsseldorf, Germany 2013.
- ❖ C. Kost; »Renewable energy in North Africa: Modeling of future electricity scenarios and the impact on manufacturing and employment«, Dissertation. Dresden; 2015.

Figure 3 1:	Illustration of the interfaces and data flows between the three models	6
Figure 3 2:	Frame scenarios for the future development	7
Figure 3 3:	Trend of the electricity demand in North Africa in 2050 in the scenario »Energy Efficiency«	8
Figure 3 4:	Cost potential curves for North Africa - 2030 and 2050	9
Figure 3 5:	Visualization of the net electricity transmission in 2050 (Scenario 3).....	11
Figure 3 6:	The 28 regions considered in NA (Source grid map:AUPDTE, 2011 [6])	11
Figure 3 7:	Modelled AC transmission grid in EU-NA by voltage level	13
Figure 3 8:	Proposed inter-European-North African HVDC overlay grid	15
Figure 3 9:	Proposed HVDC grid in Morocco (Edited extract, original from AUPTDE [6])...	16
Figure 4 1:	Process model for grid expansion, grid management and grid protection.....	18
Figure 4 2:	Abstract representation of the grid management process	19
Figure 4 3:	States of electric power supply systems	19
Figure 4 4:	Algorithm for the detection of DC line faults	20
Figure 4 5:	Left:Power plant structures of present large-scale PV power plants, Right: Possible structure of a PV power plant with medium-voltage DC distribution	21
Figure 4 6:	Left: Medium-voltage DC / DC converter, Right: Efficiency of the converter ...	22
Figure 4 7:	Properties of glass ceramics for capacitors (after [16]).	23
Figure 4 8:	Schematic representation of the built-up capacitor stack.....	24
Figure 4 9:	Metallized thin glass (left) and mounted capacitor (right)	24
Figure 4 10:	Influential factors in the optimization of a solar thermal power plant.....	25
Figure 4 11:	Performance of various power plant configurations versus annual operating hours: System A (top), System B (middle) and System C (bottom)...	27
Figure 4 12:	Methodology for determining the degradation mechanisms of materials for high-temperature storage.....	28
Figure 4 13:	Mechanisms of stress corrosion cracking.....	29
Figure 5 1:	Classification in considering recommendations for action	32
Figure 5 2:	Recommendations for the RES promotion in North Africa - Possible phases of the transition process.....	34

- [1] Kost C., Flath C., and Möst D., 2013, "Concentrating solar power plant investment and operation decisions under different price and support mechanisms," *Energy Policy* 61: 238-248, 2013.
- [2] Boie I., Pudlik M., Ragwitz M., Sensfuß F., Bohn S., Agsten M., Bretschneider P., and Westermann D., 2013, "Scenarios for Renewable Energy Deployment in North African Countries and Electricity Exchange with Europe – A Model-based Analysis for 2050," *International Journal of Smart Grid and Clean Energy (SGCE)*, Vol. 2, No. 4, 2013/14, p. 2050.
- [3] Boie I., Kost C., Bohn S., Agsten M., Bretschneider P., Snigovyi O., Pudlik M., Ragwitz M., Schlegl T., and Westermann D., 2016, "Opportunities and challenges of high renewable energy deployment and electricity exchange for North Africa and Europe - Scenarios for power sector and transmission infrastructure in 2030 and 2050," *Renewable Energy*(87/1), pp. 130–144.
- [4] European Commission, "EU energy trends to 2030 - Update 2009," https://ec.europa.eu/energy/sites/ener/files/documents/trends_to_2030_update_2009.pdf.
- [5] McKinsey, 2010, "Transformation of Europe 's power system until 2050," http://www.weltinnenpolitik.net/wp-content/uploads/2010/09/transformation_of_europe_s_power_system_until_2050.pdf.
- [6] AUPTDE, Arab Union of Producers, Transporters & Distributors of Electricity, 2010, "Electrical Network of Arab Countries (country maps)," <http://auptde.org/PublicationsFile.aspx?lang=en&CID=517>.
- [7] CIGRÉ WG B4.52, 2013, "HVDC Grid Feasibility Study," Council on Large Electric Systems, Paris.
- [8] Deutsche Übertragungsnetzbetreiber, 2012, "Grundsätze für die Planung des deutschen Übertragungsnetzes," 50Hertz Transmission GmbH, Amprion GmbH, TenneT TSO GmbH and Transnet BW GmbH.
- [9] Bohn S., Kayser J., Fetisova M., Marten A.-K., Agsten M., and Westermann D., 2014, "The Operation of a Meshed HVDC Grid – A Model-based Analysis of a Supergrid," *Australian Utility Week*, Melbourne, Australia, Nov. 2014.
- [10] Bohn S., Agsten M., Marten A.-K., Westermann D., Boie I., and Ragwitz M., 2014, "A pan-European-North African HVDC grid for bulk energy transmission - a model-based analysis," 2014 IEEE PES Transmission and Distribution Conference and Exposition (T&D 2014) Chicago, Illinois, USA, 14 - 17 April 2014 ; 2, pp. 763–767.
- [11] Bohn S., Agsten M., and Boie I., 2013, "Integrating a Pan-European HGÜ Grid into the North African AC Transmission System," *World Smart Grid Forum*, Berlin, Germany, Sep. 2013.
- [12] Marten A.-K., and Westermann D., 2012, "A novel operation method for meshed HVDC overlay grids and corresponding steady state and dynamic power flow calculation principle," *Proc IET - The 10th International Conference on AC and DC Power Transmission (ACDC 2012)*. Birmingham, UK, pp. 203–208.
- [13] Schwab A. J., 2012. *Elektroenergiesysteme: Erzeugung, Transport, Übertragung und Verteilung elektrischer Energie*, Springer-Verlag Berlin Heidelberg, Berlin, Heidelberg.
- [14] Troitzsch C., 2014. *Netzfehler in vermaschten HGÜ-Netzen: Ein Verfahren zur Berechnung, Detektion, Fehlerklärung*, Univ.-Verl. Ilmenau, Ilmenau.
- [15] Marten A.-K., Troitzsch C., and Westermann D., 2015, "Non-telecommunication based DC line fault detection methodology for meshed HVDC grids,"

- Proc. IET 11 th International Conference on AC and DC Power Transmission (ACDC 2015), Birmingham, United Kingdom, 02/2015., pp. 58–65.
- [16] Smith N. J., Rangarajan B., Lanagan M. T., and Pantano C. G., 2009, "Alkali-free glass as a high energy density dielectric material," *Materials Letters*, **63**(15), pp. 1245–1248.
- [17] Vogel A., Reiling H., Fluri T. P., and Platzer W. J., 2014, "High Temperatures in Line Focusing Systems: Dual Loop Cycle Efficiency and Heat Losses," 20th SolarPACES Conference 2014, Beijing, 16th-19th Sept. 2014.
- [18] Seubert B. T., Fluri T. P., and Platzer W. J., 2014, "Numerical Investigation and Improvement of the Standby Performance of Thermocline Storages," 20th SolarPACES Conference 2014, Beijing, 16th-19th Sept. 2014.
- [19] Zipf V., Neuhäuser A., Bachelier C., Leithner R., and Platzer W. J., 2014, "Assesment of different PCM Storage Configurations in a 50 MWel CSP Plant with Screw Heat Exchangers in a Combined Sensible and Latent Storage - Simulation Results," 20th SolarPACES Conference 2014, Beijing, 16th-19th Sept. 2014.
- [20] Zipf V., Neuhäuser A., Willert D., Nitz P., Gschwander S., and Platzer W., 2013, "High temperature latent heat storage with a screw heat exchanger: Design of prototype," *Applied Energy* 2013;109(0), pp. 462–469.
- [21] Piedra E., 2013, "Untersuchung der thermischen, mechanischen und korrosiven Degradation von Stählen in Salzschnmelzen solarthermischer Kraftwerke," Tagungsband Werkstoffprüfung 2013, Fortschritte in der Werkstoffprüfung für Forschung und Praxis, Verlag Stahleisen GmbH, Düsseldorf.